

zehnder

always the
best climate

Zehnder ComfoAir 70

User manual on operation and installation for operators and installers



Legal regulations

All rights reserved.

This user manual has been compiled with the utmost care. Nevertheless, the publisher accepts no liability for damage caused by missing or incorrect details in this manual. We reserve the right at any time and without previous notification to change the content of these instructions in part or as a whole.

The information contained in these documents is the property of Zehnder Group. Publication, as a whole or in parts, requires the written approval of Zehnder Group. In-house duplication, designated for the evaluation of the product or for proper use, is permitted and not subject to approval.

Zehnder manufacturer's warranty

The current warranty terms can be obtained in paper form using the normal distribution channels.

Trademarks

All trademarks are recognized, even if they are not separately labelled. A missing label does not mean that an article or sign is free of trademark rights.

© 2021 Zehnder Group

Contents

1	Foreword and introduction	2
1.1	Notes on the user manual.....	2
1.2	Validity	2
1.3	Target groups	2
1.3.1	Qualification of target group.....	2
1.4	Conformity	2
2	Introduction and safety	3
2.1	Hazard classification.....	3
2.2	Safety regulations	3
2.3	Installation conditions	3
2.4	Notes on the operational safety of the ventilation unit	3
2.4.1	Operation with fireplaces	3
2.4.2	Commissioning and operation	3
2.5	Notes on operation of the ventilation unit.....	4
2.5.1	Standard operation of the unit	4
2.5.2	Operating variants	4
2.6	Proper use	4
2.7	Guarantee conditions, warranty and liability	4
2.7.1	Guarantee conditions.....	4
2.7.2	Warranty	4
2.7.3	Liability.....	4
2.8	Storage	5
2.9	Environmentally friendly disposal.....	5
3	Chapter for operators and qualified personnel.....	5
3.1	Product description	5
3.1.1	Unit design and function	5
3.1.2	Overview of assemblies	6
3.1.3	Type label	6
3.1.4	Frost protection.....	6
3.1.5	Operating and display elements of the control panel.....	6
3.1.6	Description of the operating functions and signals	7
3.2	Options for ventilation operation	10
3.2.1	External control panel	10
3.2.2	Operation via networking	10
3.2.3	Automatic operation via sensor module	10
3.3	Maintenance by the user	11
3.3.1	Filter maintenance	11
3.3.2	Unit maintenance.....	13
3.3.3	What should I do in case of a malfunction?	13
4	Chapter for qualified personnel.....	14
4.1	Installation requirements.....	14
4.1.1	Packaging and handling	14
4.1.2	Checking the scope of delivery	14
4.2	Installation	14
4.2.1	General installation requirements	14
4.2.2	Installation preparations.....	14
4.2.3	Connecting ventilation tubes.....	15
4.3	Installing the ventilation unit.....	17
4.4	Electrical connections	19
4.5	Parameterisation of boost ventilation and absent operating modes.....	21
4.5.1	Configuration of the boost ventilation mode.....	21
4.5.2	Configuration of the Away mode.....	22
4.6	Commissioning	22
4.7	Specialist maintenance.....	22
4.8	Visualization of fault notifications.....	23
4.9	Technical specifications.....	23
4.9.1	Pressure loss-Volume flow-Characteristic curves for design of adjoining room connection	24
4.9.2	Dimensions with optional radio module	25
4.9.3	Terminal scheme	26

1 Foreword and introduction

1.1 Notes on the user manual



This translation of the original user manual contains basic instructions that must be followed during the installation and operation of the ComfoAir 70 ventilation unit.

- ▶ Read the instructions in full before installing and commissioning the ventilation unit. This will help you avoid hazards and errors.
- ▶ Provide the manual to the operator after the final assembly.
- ▶ The user manual forms a part of the product. Keep the manual for future reference.

WARNING

Be sure to observe all safety notes, warnings and information on precautionary measures.
Read chapter “2 Introduction and safety” carefully.

1.2 Validity

This document applies to:

- ▶ Unit type ComfoAir 70 series

The unit type series are hereinafter designated with the common product name, ComfoAir 70.

The subject of this user manual is the ComfoAir 70 in combination with an embrasure module as a facade finish. Accessories are only described to the extent necessary for appropriate operation of the unit. Please refer to the respective instructions for further information on accessory parts.

1.3 Target groups

This manual is for users and qualified personnel. The activities are only allowed to be carried out by appropriately trained personnel who are sufficiently qualified for the respective work involved.

1.3.1 Qualification of target group

1.3.1.1 Users

Users must be instructed by qualified personnel as follows:

- ▶ Instruction in hazards when handling electrical devices.
- ▶ Instructions on the operation of the ComfoAir 70.
- ▶ Instruction in the maintenance of the ComfoAir 70.
- ▶ Knowledge of and compliance with this manual, including all safety instructions.

1.3.1.2 Qualified personnel

Qualified personnel must have the following qualifications:

- ▶ Training in dealing with hazards and risks when installing and operating electrical devices
- ▶ Training for the installation and commissioning of electrical devices
- ▶ Knowledge of and compliance with the locally applicable building, safety and installation regulations of the relevant local authorities or municipalities, the regulations of the water and electric utilities, and other official regulations and guidelines
- ▶ Knowledge of and compliance with this document, including all safety instructions.

WARNING

Unless otherwise specified in this user manual, only a qualified person is authorised to install and commission the ventilation unit and to carry out servicing.

1.4 Conformity

The ComfoAir 70 series ventilation units from the manufacturer



PAUL Wärmerückgewinnung GmbH
August-Horch-Straße 7
08141 Reinsdorf
Germany
Chemnitz commercial register 21371

comply with the directives and standards of the EU and EAC Declaration of Conformity.

2 Introduction and safety

This manual contains information that must be observed for your personal safety and in order to prevent personal injury and damage to property. This information is highlighted in the form of warning notes, which are shown below according to the degree of risk.

2.1 Hazard classification

 DANGER
This signal word indicates a hazard with a high level of risk which, if not avoided, will result in death or serious injury.
 WARNING
This signal word indicates a hazard with a medium level of risk which, if not avoided, will result in death or serious injury.
 CAUTION
This signal word indicates a hazard with a low level of risk which, if not avoided, will result in a minor or moderate injury.
NOTE
In the meaning of this manual, a note includes important information about the product or the respective section of the manual to which special attention is drawn.

2.2 Safety regulations

Always observe the safety regulations and installation conditions. Failure to observe the safety regulations, installation conditions, instructions, warnings, and comments in this document can result in personal injury or damage to the unit.

- ▶ Do not make any changes to the unit or to the specifications listed in this document. Such changes can cause personal injury or lead to reduced performance in the ventilation system.
- ▶ Comply with the general locally applicable building, fire, safety and installation regulations of the relevant local authorities, the regulations of the water and electric utilities and all other official regulations.
- ▶ Installation, commissioning, and maintenance must be carried out by an authorized person or company, unless otherwise stated in this document.
- ▶ Do not disconnect the unit from the power supply unless instructions to the contrary are listed in the manual.
- ▶ Following installation, all parts that could lead to personal injury are protected by the housing. The unit cannot be opened without the use of a tool.
- ▶ Only operate the ventilation unit with the filters inserted, the housing closed and the facade finish applied.

2.3 Installation conditions

- ▶ The acceptable temperature range for the air being moved is between -20 °C and +40 °C
- ▶ The unit must not be installed in rooms subject to explosion hazards
- ▶ When installing the unit, make sure that the applicable country-specific standards / regulations for compliance with protection zones when installing electrical systems in rooms with a bathtub or a shower are observed!
- ▶ The unit must not be used for extracting combustible or explosive gases
- ▶ The unit must be connected to a fixed 230 VAC / 50-60 Hz power supply
- ▶ To switch off from the mains, a disconnection system using a contact opening width in accordance with the conditions from overvoltage category III for complete disconnection must be provided.
- ▶ Check whether the electrical installation is suitable for the maximum power of the unit.
- ▶ Check that the installation location of the unit meets the requirements in the "4.1 Installation requirements" chapter.

2.4 Notes on the operational safety of the ventilation unit

2.4.1 Operation with fireplaces

- ▶ Joint operation with fireplaces depending on the indoor air is only permissible in combination with the corresponding safety devices and in compliance with applicable laws, regulations, and standards.
- ▶ Observe the applicable regulations in the respective country during planning and installation.

2.4.2 Commissioning and operation

- ▶ Only operate the ventilation unit when it is installed.
- ▶ Only operate the ventilation unit with filters fitted.
- ▶ Only operate the ventilation unit with the upper design cover closed and engaged.
- ▶ Only operate the ventilation unit with a facade finish.



WARNING

Risk of injury from touching the fan during operation

Without an exterior wall panel, the fan is freely accessible and there is a risk of contact.
Make sure that the ventilation unit is disconnected from the power supply.

2.5 Notes on operation of the ventilation unit

2.5.1 Standard operation of the unit

This unit can be used by children aged 8 and over and also persons with reduced physical, sensory or mental abilities, or a lack of experience and knowledge provided that they are under supervision or have been instructed on the safe use of the unit and understand the risks that result from it. Children must not play with the unit. Children must not carry out cleaning and user maintenance without supervision.

2.5.2 Operating variants

The ComfoAir 70 offers the following variants that can be combined for convenient operation:

- Operation on the unit – standard version with internal control panel.
- Operation with ComfoLED – optional: External, wired control panel (max. cable length 25 m).
- Radio-based operation – optional: Radio networking via Radio module, connection hub and Zehnder Connect app.

NOTE

The external control panel and the connection hub are only suitable for use in indoor areas.

2.6 Proper use

- ▶ The ComfoAir 70 is intended for the ventilation of living rooms and spaces with a similar use. Any other use or any use beyond this is considered improper use.
- ▶ The ventilation unit is intended for use in rooms with a humidity level of approx. 40% to approx. 70% RH. It must not be installed in rooms where the relative air humidity is permanently above 80% during operation.
- ▶ The ventilation unit is not suitable for smoke extraction or drying buildings, for rooms with aggressive and corrosive gases or for rooms with extreme dust levels.
- ▶ The ventilation unit may only be operated when fully assembled with all the components (including facade finish).
- ▶ Intended use also includes observing all instructions in the user manual.

In the event of improper use, the Zehnder Group accepts no liability for any damage that may occur and no warranty for the proper and functional operation of the ventilation unit.

2.7 Guarantee conditions, warranty and liability

2.7.1 Guarantee conditions

The manufacturer grants a guarantee of 24 months from installation or a maximum of 30 months from the date of manufacture on the device. Warranty claims may only be asserted for material defects and/or design faults that have occurred during the warranty period.

The costs of removal and installation on site are not covered by the warranty. The same applies to natural wear and tear. Zehnder reserves the right to change the design and/or configuration of its products at any time with no obligation to adjust products already supplied accordingly.

2.7.2 Warranty

In the event of a warranty claim, the unit must not be disassembled without the written consent of the manufacturer. Spare parts are only covered by the warranty if they have been supplied by the manufacturer and fitted by an approved technician.

The warranty shall be null and void if:

- ▶ The warranty period has elapsed.
- ▶ The installation has not been carried out in accordance with the applicable regulations.
- ▶ The unit is operated without a filter and without a facade finish.
- ▶ Original parts have been replaced by non-original parts.
- ▶ Unauthorised changes or modifications to the unit have been made.
- ▶ The defects are due to improper installation, improper use or neglected maintenance of the system.

2.7.3 Liability

The ComfoAir 70 is intended for the ventilation of apartments, offices and similar rooms. Every other use is deemed as "improper use", and can lead to damaging the ComfoAir 70, or to personal injury, for which the manufacturer cannot be held liable.

The liability of the manufacturer becomes null and void in the following cases:

- ▶ Failure to observe the instructions specified in this manual pertaining to safety, operation and maintenance.

- ▶ Modifications to the ventilation unit or the use of components that have not been approved or recommended by the manufacturer.
- ▶ Incorrect installation, improper use or contamination of the system.
- ▶ Original parts have been replaced by non-original parts.
- ▶ Operation of the unit without filters and without a facade finish.

2.8 Storage

NOTE

Store the ventilation unit in its original packaging in a dry place at temperatures between 0°C and +40°C.

2.9 Environmentally friendly disposal

NOTE

Packaging materials, consumables and waste equipment must be disposed of at the end of their useful life in accordance with the applicable regulations in your country.

3 Chapter for operators and qualified personnel

3.1 Product description

The ComfoAir 70 is built to the current state of the art and the recognized safety regulations. The unit is subject to continuous improvement and development. This is why it is possible for your unit to deviate slightly from the description.

3.1.1 Unit design and function

The ComfoAir 70 is a decentralised comfort ventilation unit, with heat and humidity recovery, using synchronous supply and extract air operation. The ventilation unit can be used both for individual room ventilation (room-by-room) and, via connection options for ventilation tubes, for venting of a group of rooms (utilisation unit). The ventilation unit is designed for permanent operation and is only to be taken out of operation for maintenance and repair work. With the appropriate (optional) sensor technology in the unit, fully automatic, demand-controlled ventilation operation is possible.

The housing consists of a powder-coated steel plate, as well as covers made of aluminium in the RAL9016 colour scheme. The body of the unit, which is made of high-quality polypropylene (EPP), is used to house the main assemblies, provide thermal insulation and sound protection for the unit.

The enthalpy exchanger used as standard in the unit ensures a healthy, comfortable indoor climate with its high heat and moisture recovery.

Both of the maintenance-free centrifugal fans are driven by energy-efficient EC direct-current motors. The fan output in the form of the air volume flow can be adjusted in four stages. In the automatic operating mode, the air volume flow is continuously controlled.

A fully automatic shutter control activates the motorised shutters as required for standby and frost protection mode.

The ventilation unit requires very little maintenance, but it is important to change the air filter regularly. Inside the unit, there is a filter with filter class ISO coarse 70% for the outdoor air and another one for the extract air in serial production. Optionally, a filter of filter class ISO ePM10 80% can be used for filtering the outdoor air.

A device-specific, facade-integrated embrasure module is available as a facade closure.

3.1.2 Overview of assemblies

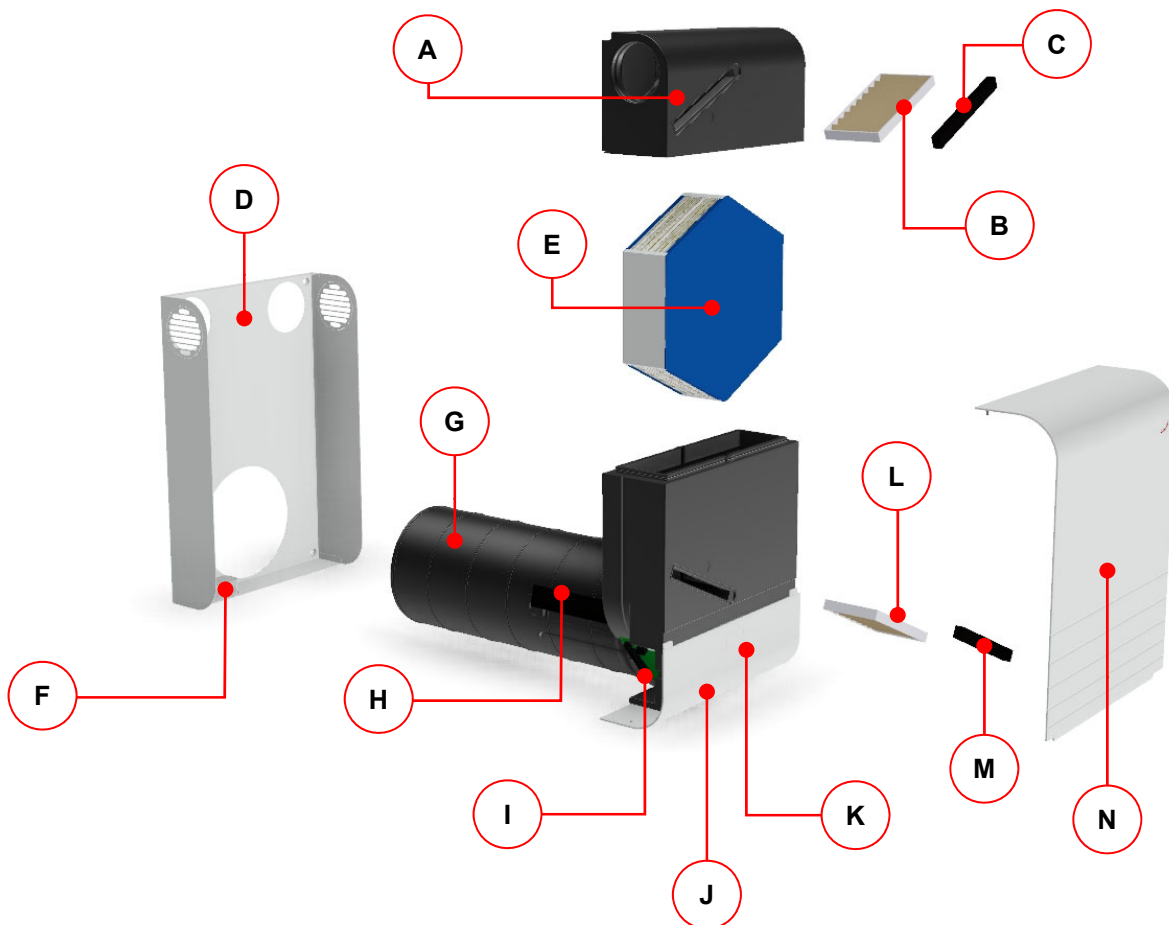

Item	Description
A	EPP housing, upper part
B	Extract air filter ISO Coarse 70 %
C	Filter cover made of cellular rubber
D	Wall bracket
E	Enthalpy exchanger (diaphragm moisture heat exchanger)
F	Terminal box, electrical connection
G	EPP-housing part tube extension
H	EPP housing unit with integrated fans and folding mechanism
I	Control board
J	Lower design cover made of aluminium, with integrated control panel
K	Touch-sensitive control panel
L	Outdoor air filter ISO Coarse 70 % or ISO ePM10 80 %
M	Filter cover made of cellular rubber
N	Upper design cover made of aluminium

3.1.3 Type label

The type label identifies the product unequivocally. The type label can be found underneath the upper design cover, on the EPP housing unit. You will need the details on the type label for the safe use of the product and in case of questions for service. The type label must be attached permanently on the product.

3.1.4 Frost protection

The ComfoAir 70 is equipped with an automatic frost protection function to prevent the thermal exchanger from icing up. In working condition, the control unit acting in frost protection mode is activated when required for the four manual fan speeds as well as in automatic mode.

3.1.5 Operating and display elements of the control panel

The control panel has touch-sensitive buttons and LED status indicators.



NOTE
The ventilation unit can be operated at the same time with the internal and the external control panel.

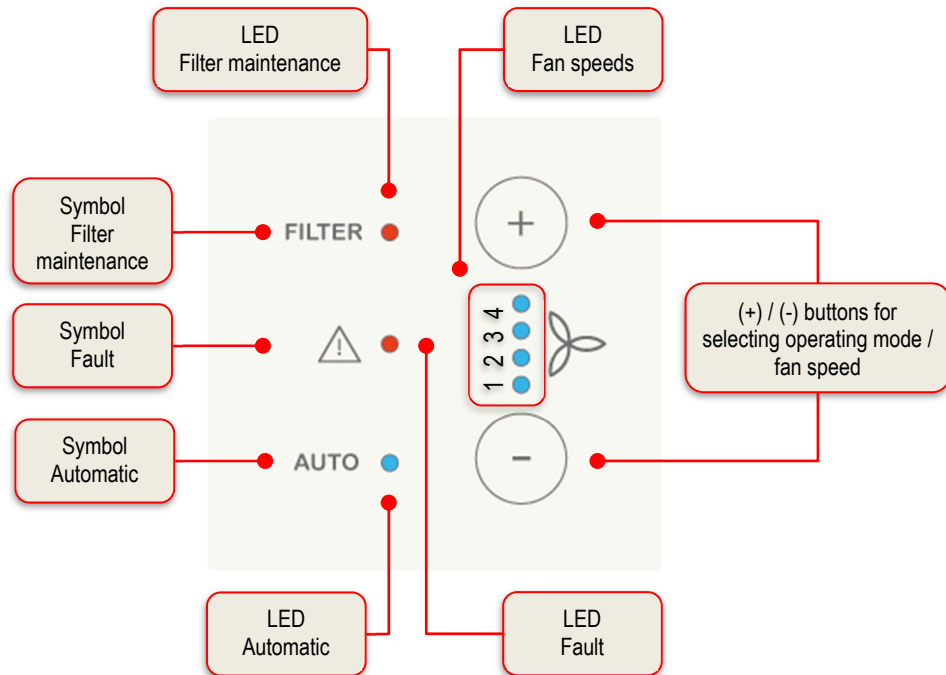



The two (+) / (-) keys are used for setting the various fan speeds and operating modes. The ventilation stages and the Automatic operating mode are indicated with blue LEDs, and the service information with red LEDs.

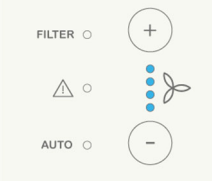

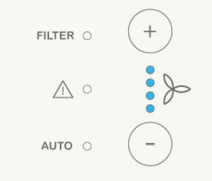
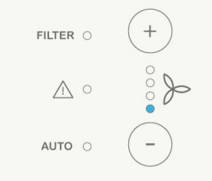
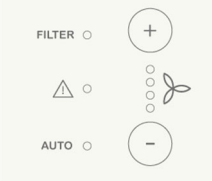
3.1.6 Description of the operating functions and signals

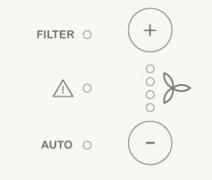
Icon	Description	Explanation
<p>LED1 lights up</p>	<p>Fan speed operating mode Manual</p> <p>Fan speed 1 (FS1)</p>	<p>The selection for the current fan speed (in total 4 fan speeds with preset speeds for each fan) is made by using the (+) / (-) buttons.</p> <p>Touching the (+) button sets the next higher fan speed and touching the (-) button sets the next lower fan speed.</p> <p>Reduced ventilation</p> <p>The ventilation unit runs at the lowest ventilation level (15 m³/h). This fan speed can be selected when away and for the purpose of moisture protection.</p> <p>NOTE</p> <p>A cyclically limited reduced ventilation can be set with the Away operating mode.</p>
<p>LED1-2 light up</p>	<p>Fan speed 2 (FS2)</p>	<p>Nominal ventilation</p> <p>The ventilation unit runs at a low ventilation level (25 m³/h). This is normal operation, used to achieve the necessary ventilation for hygienic and health requirements when users are present.</p>
<p>LED1-4 light up</p>	<p>Fan speed 3 (FS3)</p>	<p>Increased ventilation</p> <p>The ventilation unit runs at a higher ventilation level (40 m³/h) to reduce peak loads, e.g. when several people are present.</p>

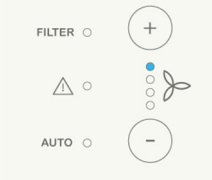
Icon	Description	Explanation
 <p>LED1-4 light up</p>	<p>Fan speed 4 (FS4)</p>	<p>Intensive ventilation The ventilation unit runs at maximum ventilation level (60 m³/h). This fan speed is used for a fast air exchange.</p> <p>NOTE Intensive ventilation for a limited period of time can be set with the boost ventilation operating mode.</p>
 <p>AUTO LED lights up</p>	<p>Automatic operating mode (AUTO)</p>	<p>NOTE The Automatic function can only be activated with a sensor module.</p> <p>Touching the (+) key from the currently active FS4 transfers the unit to AUTO fan speed. AUTO fan speed is excited by touching the (-) button, and the unit is transferred back to FS4. The Automatic function is visualized by the Automatic LED.</p>
 <p>AUTO LED lights up</p>	<p>Bathroom function operating mode</p>	<p>NOTE The Bathroom function can only be activated with a sensor module and configured DIP switch setting.</p> <p>The fans are operated at maximum speed starting from a relative room air humidity of 80%. If this limit is not reached, the previously active operating mode is applied again.</p>
 <p>LED1-4 light up</p>	<p>Boost ventilation mode</p>	<p>NOTE The boost ventilation function as temporarily activated fan speed 4 can only be activated with a configured DIP switch setting.</p> <p>After the boost ventilation time has elapsed, the unit will be transferred to the most recently selected fan speed. The fan speed that was active for longer than 10 s is deemed as the last fan speed. When boost ventilation is active, the operating modes "Extract air mode" or "Supply air mode", that may be activated, are retained.</p> <p>The duration of the boost ventilation function can be set between 5 and 120 minutes by the customer service team using the programming module. (Factory setting: 15 minutes)</p>
 <p>LED1 lights up during the active time phase</p>	<p>Away mode</p>	<p>NOTE The Away function as temporarily activated fan speed 1 can only be activated with a configured fan speed 1.</p> <p>The active operating time of the FS1 can be set between 15 and 59 min/h by the customer service team using the programming module. (Factory setting: 60 min/h $\hat{=}$ FS1 permanent operation).</p>
	<p>LED display for energy-saving mode</p>	<p>The LED display on the control panel changes after 10 seconds into energy-saving mode without operator input (unit functions remain active; the LED display is switched off). If any key is touched, the LED indicator will be activated again. Touching the button brings about no change to the operating mode, however.</p>

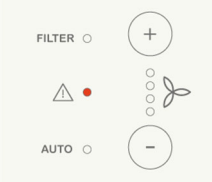
Icon	Description	Explanation
 <p>FILTER ○ (+) △ ○ (LED) AUTO ○ (-)</p>	Standby mode	<p>The unit can be switched from FS1 to Standby mode by touching the (-) button. The fans then come to a stop.</p> <p>NOTE The shutters are closed automatically.</p> <p>Standby mode is excited by touching the (+) button. The unit will start with fan speed 1.</p> <p>NOTE The shutters are opened automatically.</p> <p>There is no indication of the Standby mode from the LEDs of the control panel.</p>
 <p>FILTER ○ (+) △ ○ (LED) AUTO ○ (-)</p> <p>LED1 flashes in alternation with the current fan speed</p>	Extract air mode	<p>Touching the (-) key for 5 seconds in operating modes FS1 to FS4 activates or deactivates the Extract air mode. The supply air fan is switched off; the extract air fan continues to run with the current fan speed.</p> <p>The display for the current fan speed alternates every 2 seconds with the flashing LED1.</p>
 <p>FILTER ○ (+) △ ○ (LED) AUTO ○ (-)</p> <p>LED4 flashes in alternation with the current fan speed</p>	Supply air mode	<p>Touching the (+) key for 5 seconds in operating modes FS1 to FS4 activates or deactivates the Supply air mode. The extract air fan is switched off; the supply air fan continues to run with the current fan speed.</p> <p>If the outdoor temperature falls below 13 °C, the extract air fan will be activated.</p> <p>The display for the current fan speed alternates every 2 seconds with the flashing LED4.</p>
 <p>FILTER ○ (+) △ ○ (LED) AUTO ○ (-)</p> <p>LEDs1-3 flash Flashing of most recently active fan speed when supply air fan is switched off (Display of LED1-3 as example)</p>	Frost protection mode	<p>From an outside air temperature of -4°C, the frost protection function is automatically activated.</p> <p>In frost protection operating mode, the ratio between the supply air and extract air volume flow is automatically adjusted depending on the outside air temperature, and the unit is shut down if the outside air temperature is lower than -15°C. A check is made regularly as to whether the temperature conditions in regard of frost protection have changed, and the respective operating mode (requiring frost protection) is activated automatically according to the result of that check.</p> <p>After the unit is switched off, a flashing in those LEDs (by touching the (+) or (-) key) which denoted the most recently active fan speed will be signalled. The fan speed cannot be changed and is signalled with the flashing of Fault LED</p> <p>NOTE Changing from a higher to a lower fan speed may not be possible depending on the currently active frost protection routine. The shutters are closed or opened automatically depending on the currently active frost protection routine.</p>
 <p>FILTER ○ (+) △ ○ (LED) AUTO ○ (-)</p> <p>Fault LED flashes</p>	Indication of locked modes	<p>If an inaccessible operating mode is selected, it will be signalled by the flashing of Fault LED.</p> <p>These operating modes are the locked standby, locked supply and extract air mode and complete switch-off due to frost protection.</p>

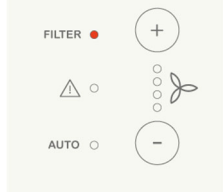
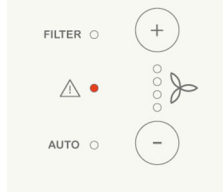
Icon	Description	Explanation
 <p>LED filter maintenance flashes</p>	Indication Filter maintenance	<p>The filters are monitored based on running time. 90 days are preset by default.</p> <p>After the filter runtime has elapsed, notification in regard of a filter maintenance is signalled by the filter maintenance LED flashing.</p> <p>Simultaneously touching the (+) and (-) keys for 3 seconds allows you to acknowledge the indication of the filter maintenance and to reset the filter runtime.</p>
 <p>Fault LED lights up Error code LED1-4</p>	Signalling of error code fault message	<p>If an error occurs, this is signalled by the fault LED.</p> <p>Faults that can be diagnosed by the unit are symbolized by LED1-4 using an error code.</p> <p>Simultaneously touching the (+) and (-) keys for 3 seconds allows you to delete the indication of the fault notification.</p>

3.2 Options for ventilation operation

The ComfoAir 70 can also be equipped with optional accessories for convenient operation and demand-controlled ventilation mode.

NOTE

Ventilation operation by means of optional accessories requires the installation and configuration of those accessory components.

3.2.1 External control panel

The Zehnder ComfoLED external control panel offers the possibility to operate the ventilation unit at a distance from the integrated control unit. The operating and display elements of the external control panel correspond to those on the internal control panel installed on the unit. If an external control panel is installed, the internal control panel supplied as standard remains fully functional.

3.2.2 Operation via networking

3.2.2.1 Operation via radio module

Ventilation units in a ventilation zone can be easily networked with each other using radio modules. The function of the ventilation units is synchronised. The settings are still made on the internal or external control panels. Mixing systems with ComfoSpot 50 series ventilation units in a common ventilation zone are possible.

3.2.2.2 Operation via the connection hub and Zehnder Connect App

Using the connection hub and Zehnder Connect App, ventilation units with a radio module in a residential unit can be conveniently operated via a mobile device. This allows complex networks to be set up. The central point of these networks is the Zehnder connection hub. It serves as an interface between the ventilation units, the mobile end devices (app) and, if available, a WLAN network with Internet connection for operating the units while away.

Mixed systems with ComfoSpot 50 series ventilation units in a common residential unit are possible.

3.2.3 Automatic operation via sensor module

The application of the Automatic function follows the logic of a demand-controlled system for optimizing the indoor air quality. Consequently, an optimized response is achieved, and mildew formation is prevented, which ultimately also leads to an increase in energy savings. The ventilation unit of the ComfoAir 70 series with a sensor module is classified in energy efficiency class A.

NOTE

The automatic operating mode switches to frost protection operating mode if frost protection criteria are met.

3.2.3.1 Functional principle of HUMIDITY sensor

NOTE

The HUMIDITY sensor module is primarily supposed to be installed in units for the ventilation of rooms with an increased occurrence of humidity.

The HUMIDITY sensor module is equipped with a combined humidity and temperature sensor and calculates the relative humidity. In the evaluation of the current sensor signal for the setpoint selection, the fans are regulated in accordance with the characteristic curve in diagram 1. Since the dehumidification performance decreases the smaller the temperature

difference between indoor and outdoor air, at a difference of $\Delta T < 5 \text{ K}$ the air volume is reduced to 20 m³/h. When the Bathroom function operating mode is active, the unit will be operated with the highest fan speed if the relative humidity amounts to 80% or more.

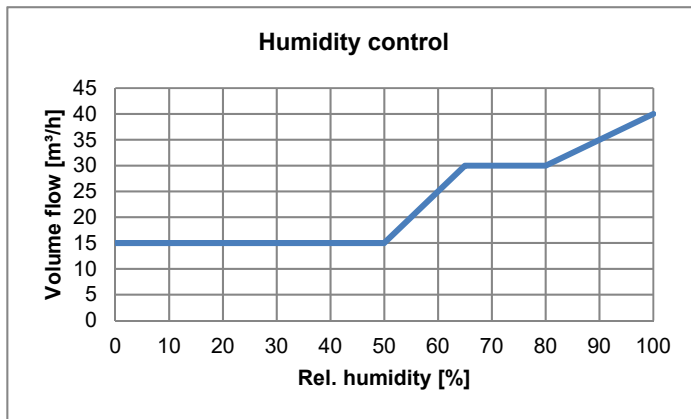

Diagram 1: Factory setting characteristic curve for Automatic operating mode with humidity control

3.2.3.2 Functional principle of CO₂ / VOC sensor

NOTE
The CO₂ sensor module and the VOC sensor module are each combined with a humidity/temperature sensor.

The CO₂ sensor module and the VOC sensor module both offer the option to evaluate relative air humidity as well as the air quality for controlling the ventilation unit. The VOC sensor module detects volatile organic compounds (VOC) and the CO₂ sensor module, as NDIR sensor (nondispersive infrared sensor), detects carbon dioxide (CO₂). Volatile organic compounds correlate with the CO₂ concentration in living spaces. In the evaluation of the current sensor signal for the setpoint selection, the fans are regulated in accordance with the characteristic curve in diagram 2.

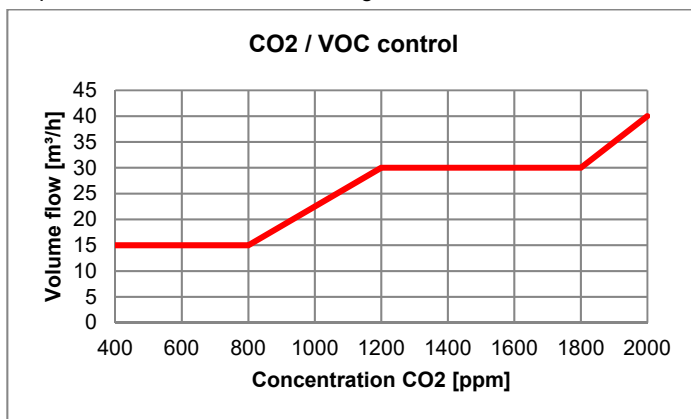

Diagram 2: Factory setting characteristic curve for Automatic operating mode with CO₂ / VOC control

NOTE
The CO₂ and VOC sensor modules combined with a humidity/temperature sensor can be deactivated separately if needed, in accordance with the humidity or air quality control. The HUMIDITY sensor technology is primarily supposed to be installed in units for the ventilation of rooms with an increased occurrence of humidity. However, if both sensor functions are configured as active, the control characteristic of the higher sensor signal becomes effective.
The required hardware settings on the control system are only allowed to be made by qualified personnel.

3.3 Maintenance by the user

Maintenance work on the ventilation unit is limited to filter replacement and external cleaning as required.

NOTE
If the maintenance work is not carried out regularly, this will affect the functionality of the ventilation unit in the long run, in particular in the case of a failure to perform filter maintenance.

3.3.1 Filter maintenance

The ventilation unit has a runtime-controlled filter monitoring system with visual indication via the filter maintenance LED. The filter monitoring period is 90 days as standard but can be adjusted to a period of between 30 and 180 days by the customer service department using a programming module.

NOTE
If the air is heavily polluted (e.g. with road traffic, industrial use, in rooms with increased dust levels), change the filters every three months.

3.3.1.1 Replacing the air filter

NOTE
The ventilation unit must not be operated without filters. During filter maintenance, the unit needs to be transferred to the Standby operating mode.

The ventilation unit is equipped with two air filters of filter class ISO Coarse 70% as standard. Retrofitting with filters of filter class ISO ePM10 80% is possible, preferably the higher quality ePM10 filter is inserted into the lower filter compartment as an outdoor air filter. No tools are needed to change the air filter. Proceed as follows with the relevant filter maintenance LED signal:

1. Put the unit into the Standby operating mode.
2. Remove the upper design cover by pulling it out of the guides in an upwards direction.

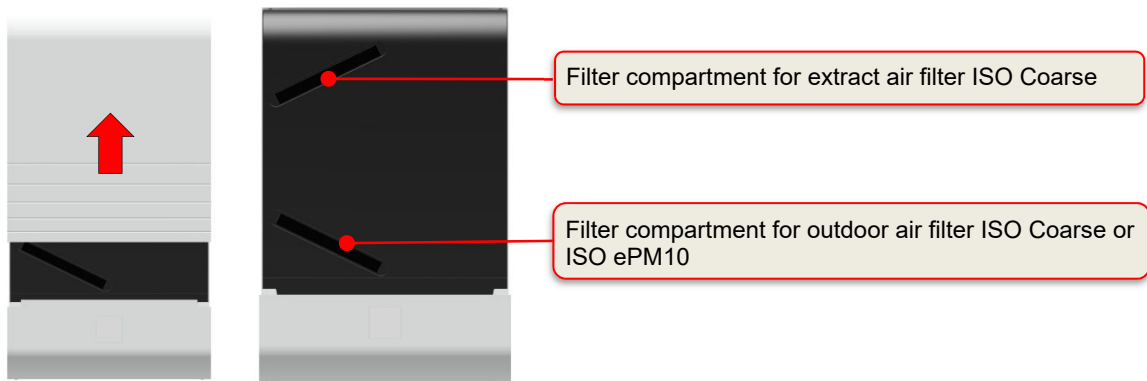

3. Use your finger to go into the recess between the filter cover made of cellular rubber and the EPP housing, and pull the filter cover out.

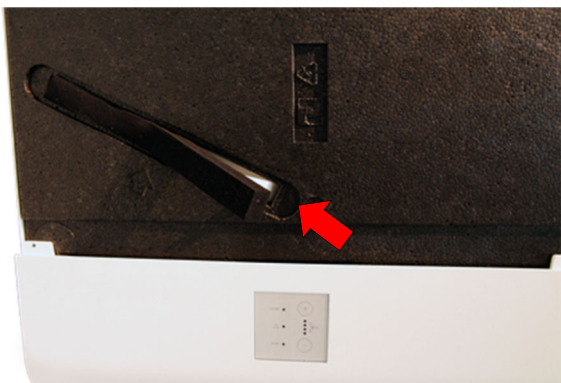

4. Gripping the pulling tabs, pull the filter carefully out of the filter compartment.

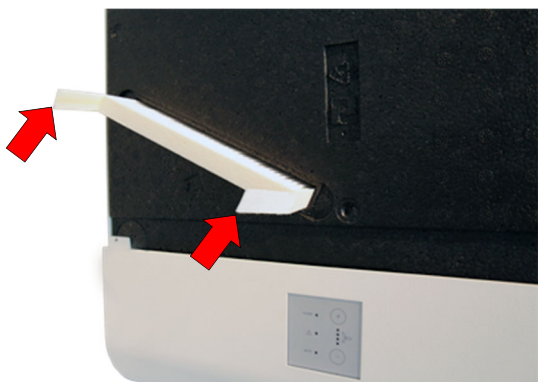

5. Using the directional arrow of the filter label pointing to the centre of the unit, insert the new filter into the filter compartment. Make sure that the filter is not pushed into the housing with force.

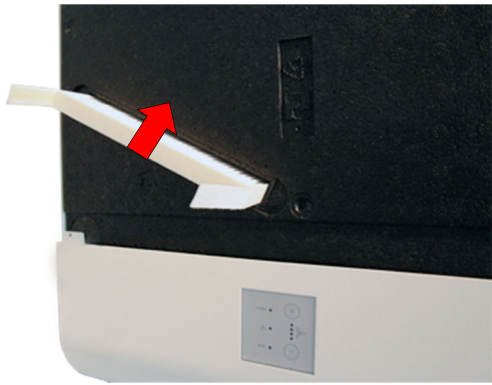

- Put the upper design cover onto the unit from above. Make sure that it engages, both in the guide for the lower design cover as well as with the locking nipples, into the designated spring clips of the wall bracket.

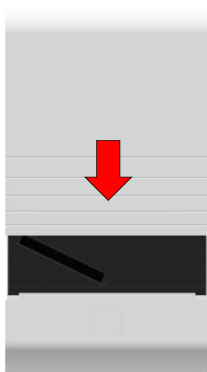

- Switch the unit back into the desired operating mode.

3.3.1.2 Resetting the filter maintenance display

The filter maintenance indicator must be reset after each air filter change in order to restart the filter maintenance cycle monitoring. To do this, touch the (+) and (-) keys on the control panel simultaneously for three seconds. The flashing red filter maintenance LED will go out.

NOTE

As part of filter maintenance for units with a second room connection, check any other air filters that may be present in the ventilation system.

3.3.2 Unit maintenance

Maintenance of the unit is limited exclusively to the external surfaces of the ventilation unit and the operating surface of the control panel, which should be wiped down from time to time using a soft, damp cloth – never just wipe dry.

⚠ WARNING

Risk due to electric shock

- Disconnect the ventilation unit from the power supply before cleaning.
- Make sure that no moisture can enter the inside of the housing during cleaning.
- Never use a high-pressure cleaner, steam cleaner or steam jet.

NOTE

Never use flammable, acidic, corrosive or abrasive cleaning agents.

3.3.3 What should I do in case of a malfunction?

In the event of a fault message (indicated by the LED fault lighting up continuously), contact customer service. Information about the type of your ComfoAir 70 can be found on the type label, which is located under the design cover of the unit.

NOTE

As a reaction to a fault status, the fans are shut down and the shutters automatically closed. As soon as there is a disconnection, the apartment will no longer be mechanically ventilated. This may result in moisture and mould problems in the room that requires ventilation.

4 Chapter for qualified personnel

4.1 Installation requirements

The following requirements must be assured for the correct installation:

- ▶ Installation in accordance with the general and locally applicable safety and installation regulations from, among others, the electric utility, and in accordance with the regulations stipulated in this manual.
- ▶ Outside wall with final construction thickness of minimum 275 mm.
- ▶ Sufficient space from objects and for maintenance work (at least 10 cm on extract air side, 20 cm on the supply air side, 80 cm at the front, and 20 cm above the unit), with regard to the housing surfaces when installed.
- ▶ Minimum distances on the facade side for outdoor air 10 cm, for exhaust air 20 cm; recommended suction opening for the outdoor air with respect to the ground >1 m, however, at least unpolluted air in the suction area.
- ▶ Electrical connection for stationary units for a working voltage range between 100–240 VAC / 50–60 Hz.

4.1.1 Packaging and handling

The ventilation unit are packed in a transport-safe box. Proceed with care when unpacking and handling the ComfoAir 70.

NOTE

Do not damage or dispose of the packaging before final installation of the ventilation unit.

4.1.2 Checking the scope of delivery

If damages or incompleteness should be determined at the delivered product, please contact the supplier immediately. Included in the scope of delivery are:

- ComfoAir 70, including installation kit
- Mounting template as imprint on the inside of the lid of the box
- User manual
- Product labels for energy-efficiency label

4.2 Installation

4.2.1 General installation requirements

The following requirements and precautions at the installation site must be taken into account:

WARNING

Observe accident prevention regulations

Observe the accident prevention regulations when setting up the installation site.
Secure the outside area against falling parts.

WARNING

Danger due to escaping gas or electric shock

Make sure that there are no supply lines (e.g. electricity, gas, water) in the area of the external wall opening.
Ensure that the external wall opening meets the static requirements on site.

WARNING

Risk due to electric shock

Observe the country-specific standards/regulations for compliance with the protection areas for installation in rooms with a bathtub or shower with regard to the IP20 degree of protection applicable to the ventilation unit.

CAUTION

Risk of injury due to falling design cover

The ComfoAir 70 is intended exclusively for installation in an external wall, whereby the housing must be positioned vertically on the inside of the wall with the exhaust and supply air grilles at the top.

NOTE

The electronics/control unit can be damaged by static charge; which is why you must always take measures to prevent electrostatic discharge when handling the control unit (e.g. by wearing an anti-static armband).

4.2.2 Installation preparations

4.2.2.1 Installation preparations for facade connection embrasure module

Before installing the ventilation unit, the specific embrasure module designed for the ducting of the outdoor and exhaust air for the ComfoAir 70 is to be installed at the designated location for the installment at the outer wall. The wall mounting

pipe which is permanently fixed to the deflection adapter of the embrasure module must be adapted flush to the dimension of the finished wall construction (room-sided).

HINWEIS

The installation of the ComfoAir 70 requires the use of the round wall installation pipe, which is a permanently connected component of the embrasure module.

When installing the embrasure module, observe the enclosed instructions for professional installation.

Use the mounting template in order to transfer all centrings for the holes onto the inner wall surface.

4.2.2.2 Preparations for installing electrical connections

The mains cable for the power supply and, if necessary, the control cable for connecting an optional external control panel must be inserted into the unit through the cut-out in the wall bracket. The cable ends should protrude approx. 10 cm from the wall surface in the area of the cable entry point in order to establish secure clamp connections with the cables on the unit side.

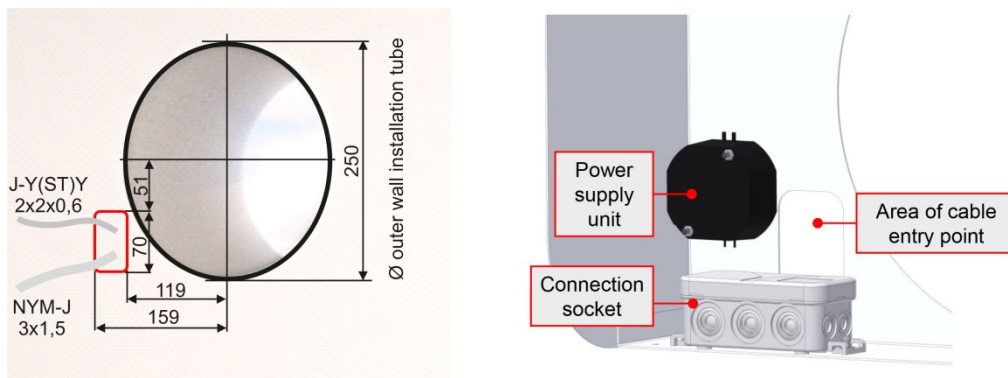

NOTE

For the power supply, a mains cable (recommended type NYM-J 3x1.5) for stationary units with disconnection with a contact opening width corresponding to the conditions of overvoltage category III for full disconnection must be provided on site.

For the connection of an optional, external control panel, a control cable (recommended type J-Y(ST)Y 2x2x0.6) must be laid on site between the external control panel and the ventilation unit.

4.2.3 Connecting ventilation tubes

The ventilation unit has four ventilation tube connection options in the upper EPP housing section for direct ventilation of a room network.

These openings for connecting ventilation tubes must be made on site if necessary when the unit is installed, since the ComfoAir 70 is supplied as a single room ventilation unit in the standard version.

NOTE

The ventilation tubes can be installed either on the side and/or on the back of the unit.

It is not permissible to connect one ventilation tube of the same type to the side and one to the back of the connector.

Components and accessories from the Zehnder product portfolio are recommended as ventilation tube material.

The ventilation tubes in an adjoining room connection have an effect on the volume flow balance of the ventilation unit. The customer service team is to use the programming module to balance the system according to the system characteristics curve.

4.2.3.1 Back connection of the ventilation tube

To connect the ventilation tube to the back wall of the unit, remove the end caps from the upper EPP housing section. Close the respective side connector with the removed end cap.

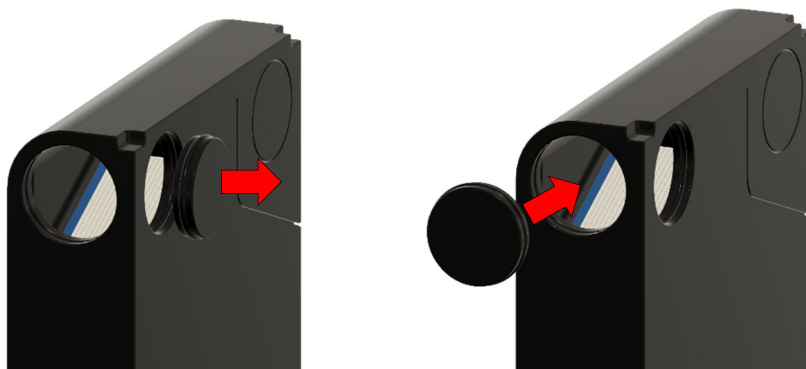

Graphics as an example for the connection of a back supply air ventilation tube

NOTE

When using the joining piece ("Convertor 90 to flat 51, bend 90°"), the connecting 51 flat duct must be routed in a downward direction, and then only using a 90° angle ("Bend flat 51 H") to the left or to the right. The reason for this is the fixing point of the wall bracket, where the fixing point is not allowed to be located in the vicinity of the flat duct.

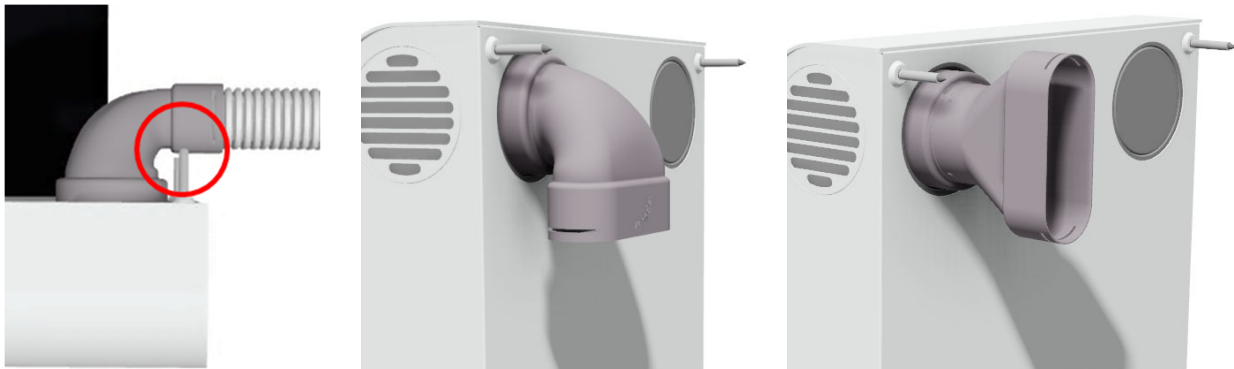

When mounting the unit on drywall or on an in-wall installation, use shorter screws or dowels with a maximum length of 35 mm.

Install the ventilation tubes air-tight at the designated connectors. For this purpose, use the recommended self-adhesive sealing tape (accessory item), which must be stuck on the outside over the entire circumference of the connector.

For correct installation, the appropriate joining piece must protrude so far out of the wall so that the connector with the attached sealing tape is inserted in the EPP housing section.

4.2.3.2 Side connection of the ventilation tube

If the ventilation tube is connected at the side, the pre-perforated external wall grille of the wall bracket must be removed. To do this, cut the two web connections of the external wall grille with the wall bracket by rotating the grille around the axis of the webs until the predetermined breaking point breaks.



Graphics as an example for the connection of a side supply air ventilation tube

⚠ CAUTION

Injury at sharp-edged predetermined breaking point of the web connections

After cutting out the external wall grille, carefully deburr the remaining material of the two web connections at the wall bracket cut-out.

The corresponding connection piece must be pushed into the groove of the opening of the EPP housing section until the sealing tape (for joining piece "Convertor 90/75 to flat 51") or the lip seal (for joining piece "Comfotube 90 / DN100") is engaged.

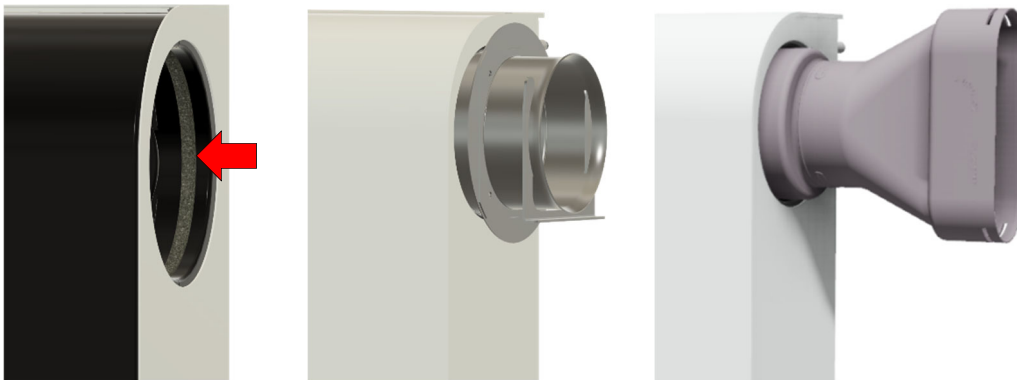

NOTE

The side connection of the ventilation tubes must be designed so that it can be dismantled for maintenance / repairs, i.e. it must be possible to pull the connection piece out of the cut-out in the upper EPP housing section.

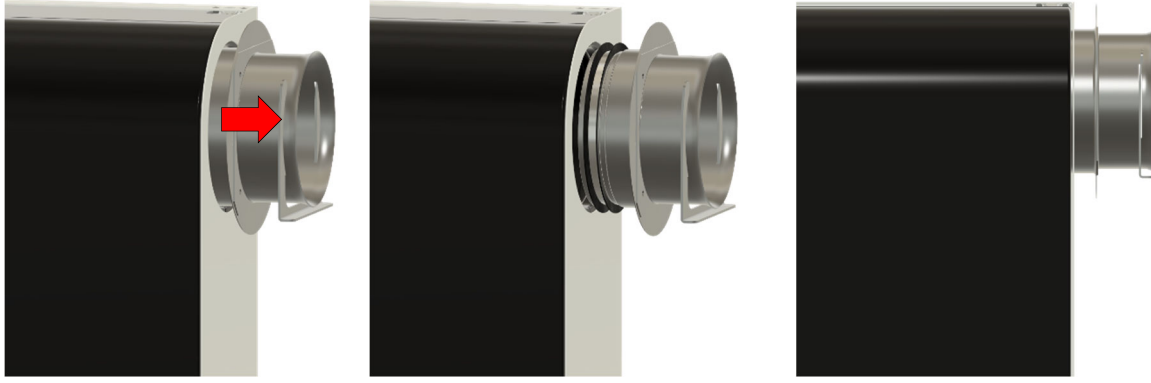

4.3 Installing the ventilation unit

DANGER

Fatal voltages

Disconnect all poles of the mains cable intended for connection to the ventilation unit from the power supply before carrying out installation and maintenance work.

Proceed as follows for the installation of the unit:

NOTE

Remove the transport lock attached to protect the lid mechanism. Follow the instructions on the yellow sticker located on the EPP housing unit exactly.

1. Pull the upper outer cover upwards and out of the bracket and undo the two screws to remove the lower design cover. Be sure to hold the lower design cover while doing so.



2. Pull the ribbon cable on the inner side of the design cover, gripping the red plug, carefully off the board of the internal control panel.



3. Remove the wall bracket from the EPP housing so that the unit is now available with no housing components.
4. If necessary, shorten the EPP-housing part tube extension in such way that the whole EPP-tube housing is equivalent to the length of the wall mounting pipe + 5 mm.

$$\text{Length EPP-tube housing [mm]} = \text{Length wall mounting tube [mm]} + 5 \text{ mm}$$

NOTE

The cut must be performed in the shortening area all around, perpendicular to the axis of the EPP pipe housing.

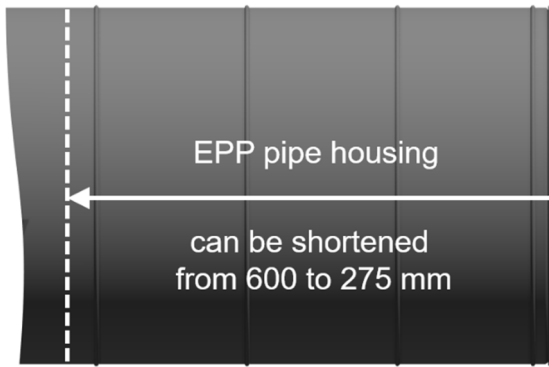

5. Drill the four holes in accordance with the mounting template for fixing the wall bracket, and insert the supplied, or, depending on the wall construction, relevant mounting material (wall plugs) into the holes.

NOTE

Use the mounting template on the lid of the box or the wall bracket as an aid for marking the required holes for mounting the wall bracket.

6. Screw the wall bracket to the inner wall and take care to ensure that the mains supply line and, if present, the cable for the external control panel, are located in the area of the cable entry point.
7. Now carry out the electrical installation steps described in chapter "4.4 Electrical connections".

⚠ WARNING

The activities described in this chapter may only be carried out by skilled personnel with the following qualifications:

- Training on the installation and commissioning of electrical units.
- Training on electrical hazards and local safety regulations.
- Knowledge of the relevant standards and guidelines.

NOTE

Optional accessories, such as sensor modules, wireless or wired operating modules, must be installed before the power supply connection. For this purpose, use the installation instructions enclosed with the respective accessories.

8. Fasten the lower design cover using the left-hand screw. The lower design cover can now be pivoted. Connect the ribbon cable to the control panel as shown.

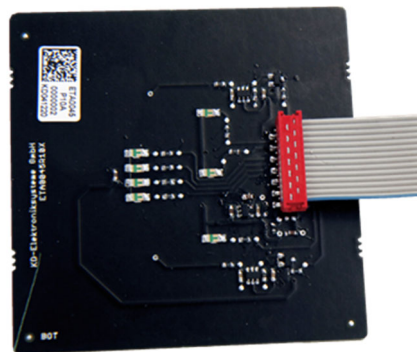

9. Push the unit into the wall mounting pipe until it stops against the back of the wall bracket. Make sure that the connection cables are not between the EPP housing and the wall bracket.



NOTE

In the end position, the front side of the EPP housing has to line up with the front edges of the wall bracket, or at least stand back behind it; if necessary, the wall bracket must be adjusted using spacers.
For easier insertion of the ventilation unit, it is recommended to wet the wall mounting pipe using silicone spray.

10. Pivot the lower design cover against the EPP housing. In the process, press the lower design cover slightly away from the wall bracket in order to pivot it in front of and past the edge of the wall bracket without a collision occurring.



NOTE

Take care to ensure that the ribbon cable is located in the designated recess of the EPP housing when installing the lower design cover.

11. Fix the lower design cover in place on the wall bracket using the two screws and put the upper design cover onto the EPP housing.

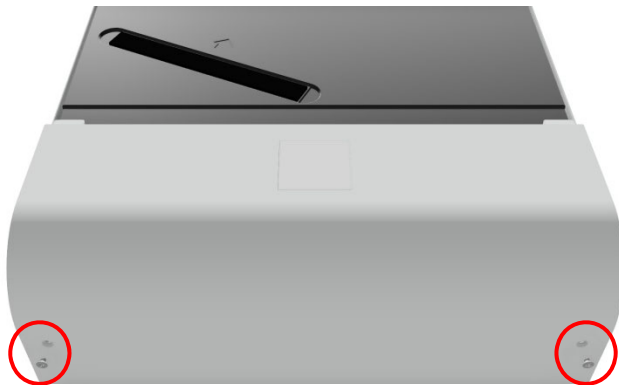

4.4 Electrical connections

DANGER

Fatal voltages

Only a qualified electrician may carry out the electrical installation.

The VDE regulations or the special safety regulations of your country apply to the electrical installation.

Observe the five safety rules (DIN VDE 0105-100 when working on electrical systems:

- ▶ Disconnect (all-pole disconnection of a system from live parts)
- ▶ Secure against restarting
- ▶ Determine absence of voltage

- ▶ Grounding and short-circuiting
- ▶ Cover or block off adjacent live parts

When connecting, proceed as follows for the power supply of the unit:

1. Guide the mains supply line and the power supply unit's primary-side power cable into the connection socket.



⚠ DANGER

Danger due to electric shock

The wires for the mains supply line and the wires for the primary-side power cable of the power supply unit must be installed in perfect condition into the connection socket with double insulation through the cable bushings.

2. Plug the WAGO lighting terminal (3 pieces included in the installation kit) with the plug-in terminal connection for solid conductors onto a stripped wire of the power supply line.

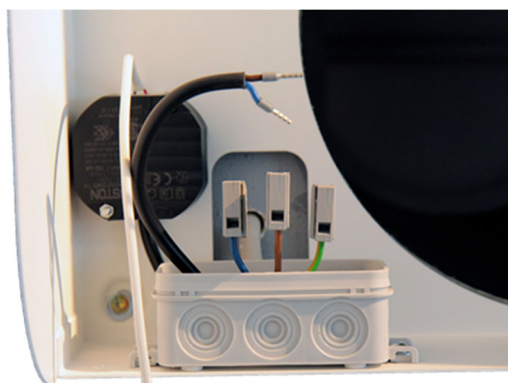
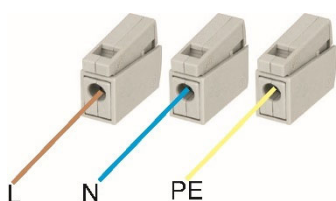

3. Connect one wire from the primary-side power cable of the power supply unit respectively to the clamping connection for the stranded wire of the WAGO luminaire terminal for the L-conductor and the N-conductor. The WAGO lighting terminal of the PE conductor remains unassigned on the unit side (ventilation unit corresponds with protection class II – protective insulation).

Wires for primary-side cable, power supply unit

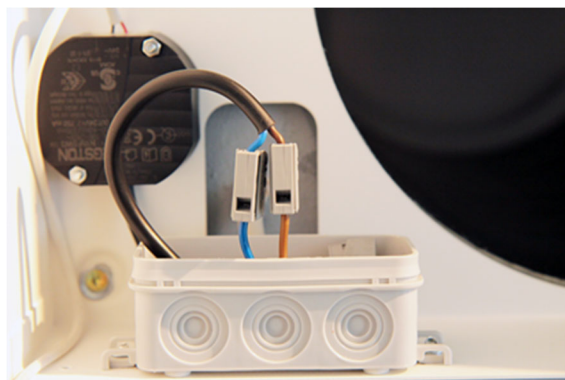
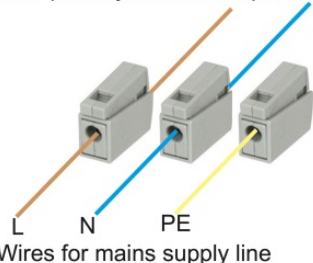

4. Get the clamping connections in the connection socket and close them using the cover.

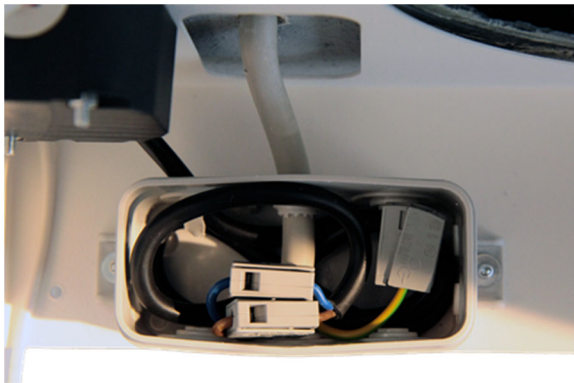

- Then insert the complete EPP housing of the ventilation unit into the wall mounting tube up to a distance of approx. 15 cm from the wall bracket so that the control board is still freely accessible.



- Connect the secondary-side stranded wires of the power supply unit to the 24 V X6 terminal on the control board.

NOTE

Watch out for the secondary-side, polarity-dependent terminal assignment.

Stranded wire colour coding	Polarity of 24 V X6 terminal
red	+
black	-

Terminal X6
Control board
operating voltage



Wires for secondary-side
cable, power supply unit

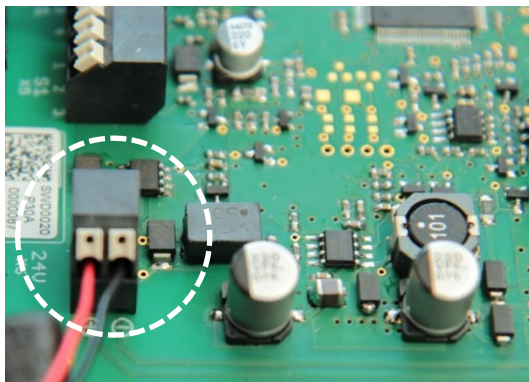

4.5 Parameterisation of boost ventilation and absent operating modes

As described in "3.1.6 Description of the operating functions and signals", the boost ventilation and absent operation modes can be adjusted according to user-specific needs.

NOTE

Parameterisation must be carried out in the accessible status of the control board.

4.5.1 Configuration of the boost ventilation mode

The temporarily active fan speed 4 operates as the boost ventilation function. To enable boost ventilation mode, DIP switch no. 3 in MODE SW1 must be set to the ON position.

DIP switch no.	Position of DIP switch
3	ON

The boost ventilation time can be parameterised between 5 and 120 minutes with the programming module.

4.5.2 Configuration of the Away mode

The temporarily activated fan speed 1 operates as the Away function. The active operating time of fan speed 1 can be parameterised between 15 and 59 min/h with the programming module.

4.6 Commissioning

NOTE

Perform the commissioning process in compliance with the specifications in chapter "2.4.2 Commissioning and operation".

Proceed as follows for the initial commissioning:

1. Check the ventilation unit for any damage and for the presence/completeness of all safety and functional assemblies.
2. Energise the mains supply line to establish the operating voltage at the ventilation unit.
3. After an initiation phase of approx. 3 seconds, indicated by the LEDs lighting up, the operating modes can be tested.

4.7 Specialist maintenance

Inspection and cleaning of the enthalpy exchanger must be carried out at two-yearly maintenance intervals.

NOTE

Instructions for proper disinfection can be found at www.core.life.

In doing so, proceed as follows:

1. Disconnect the ComfoAir 70 from the supply voltage.
2. Remove the upper design cover. Undo the right-hand fastening screw for the lower design cover and pivot it to the left.

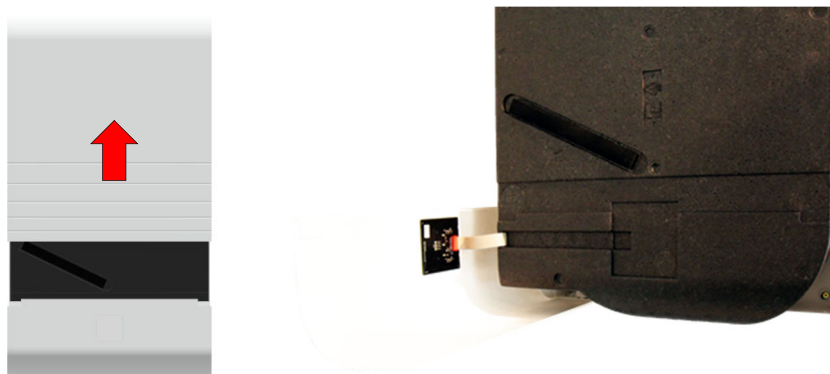

NOTE

For units with ventilation tubes connected at the side, the joining pieces must be removed.

3. Pull the unit carefully out of the wall mounting pipe until the rear side of the upper EPP housing is in front of the top edge of the wall bracket.

NOTE

If a sensor module is installed, then the sensor cable must be disconnected at the SENSOR X8 clamping point on the control board and withdrawn from the recess in the lower EPP housing.

In order to have free access to the control board, the EPP housing must be pulled out a little further. To do so, the plug on the ribbon cable must be removed from the control panel, and the lower design cover unscrewed.

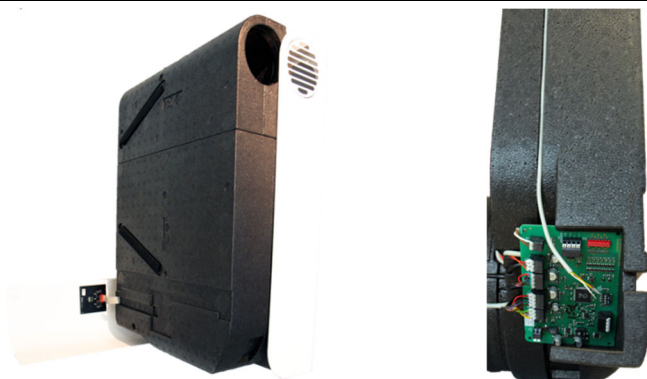

4. Remove the filter cover and the filter out of the upper filter compartment.

5. Remove the upper part of the EPP housing, pulling in an upward direction. The enthalpy exchanger can now be pulled upwards out of the lower part of the EPP housing.

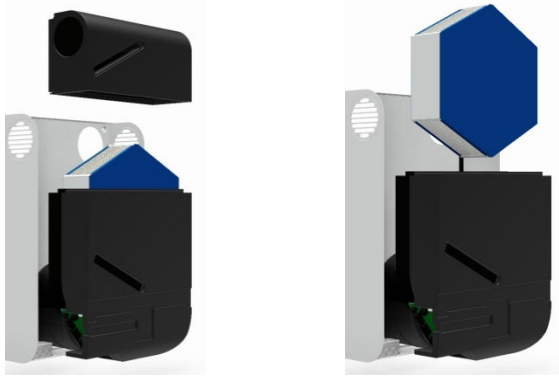

6. Proceed as follows when cleaning:

NOTE

Do not use aggressive or solvent-based cleaning agents.

- ▶ Immerse the enthalpy exchanger a few times in warm water of max. 40°C.
- ▶ Then rinse off the enthalpy exchanger thoroughly with warm tap water of max. 40°C.
- ▶ Place the enthalpy exchanger in the installed position for approx. 15 minutes so that the residual water can drain out of the openings.

7. Following the inspection, install all parts in the reverse order.

NOTE

If necessary, dismantled ventilation tubes must be reconnected in an air-tight manner.

8. Restore the power supply and set the ventilation unit to the operating mode desired by the operator.

4.8 Visualization of fault notifications

The unit control system is equipped with an internal system for recognizing faults. A fault notification is visualized through the flashing of the red "Fault LED" and a coded failure prediction using LED1-4.

Fault	LED1	LED2	LED3	LED4
Fan 1	flashes	-	-	flashes
Fan 2	-	flashes	-	flashes
Temp. sensor outdoor air	-	-	flashes	flashes
Servo 1	flashes	-	flashes	flashes
Servo 2	-	flashes	flashes	flashes
Humidity sensor	flashes	flashes	-	flashes
CO ₂ / VOC sensor	-	-	-	flashes

4.9 Technical specifications

General specifications	Description / Value
Heat exchanger type	Enthalpy exchanger with polymer membrane
Housing / Interior lining	Aluminium, powder-coated, free of thermal bridges; interior lining is made of expanded polypropylene (EPP) to provide heat and sound insulation
Pipe connections	DN 100 (sleeve size)
Weight	13 kg
Operating voltage	230 V AC (working voltage range 100 to 240 V AC)
Mains frequency	50 to 60 Hz
Rated current	0.15 A
Protection class	II
Degree of protection	IP 20
Temperature ranges	-20 to 40 °C
Installation location	In a wall mounting pipe of the embrasure module with casing on the inside of a perpendicular external wall; wall thickness min. 275 mm to max. 580 mm in connection with facade finishing embrasure module
Mounting position	In-wall casing with supply and exhaust air openings at the top

Operation data				
Fan speed	Volume flow [m³/h]	Thermal efficiency [%]	Humidity efficiency [%]	Power consumption [W]
Standby	-	-	-	< 1
FS1	15	90	84	4
FS2	25	83	73	5
FS3	40	76	61	9
FS4	60	71	54	17
Sound data housing emission				
Sound pressure level L_p in [dB(A)], free-field conditions with 3 m clearance				
Fan speed	Standard	1 adjoining room connection	2 adjoining room connections	on the outside
FS1	11,0	9,2	2,9	13,9
FS2	23,6	16,3	16,0	25,0
FS3	29,4	24,3	16,2	34,6
FS4	36,4	31,2	22,7	44,9
Sound data sound passage (with embrasure module)				
Working condition of shutters	Weighted sound reduction index $R_{l,mw} (C; C_{tr})$ [dB]		Weighted normalized level difference $D_{l,mw}$ [dB]	
Shutters open	17 (-1; -3)		40	
Shutters closed	25 (-1; -4)		48	

4.9.1 Pressure loss-Volume flow-Characteristic curves for design of adjoining room connection

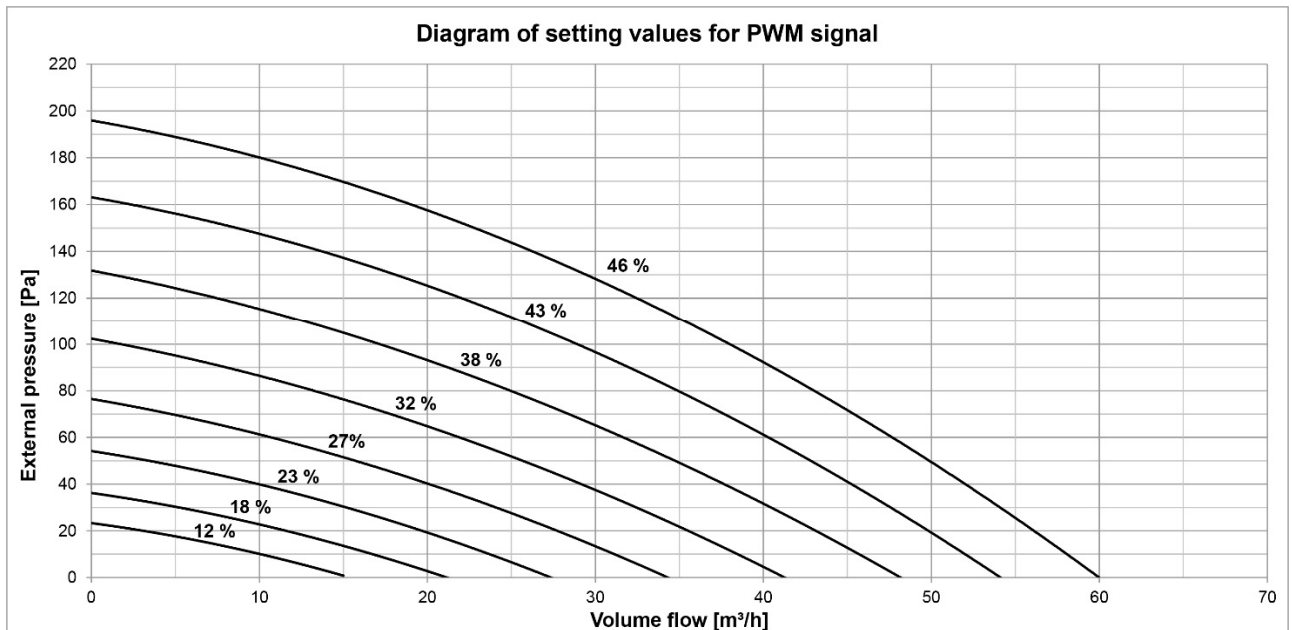

4.9.2 Dimensions with optional radio module

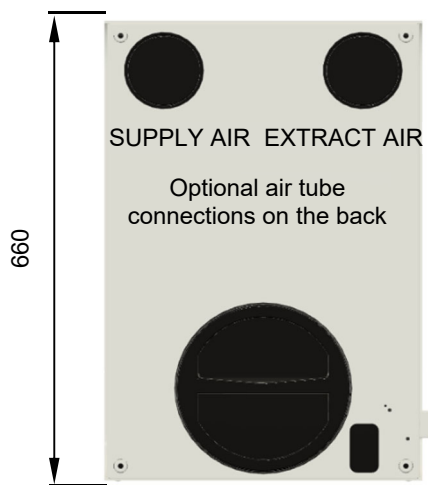
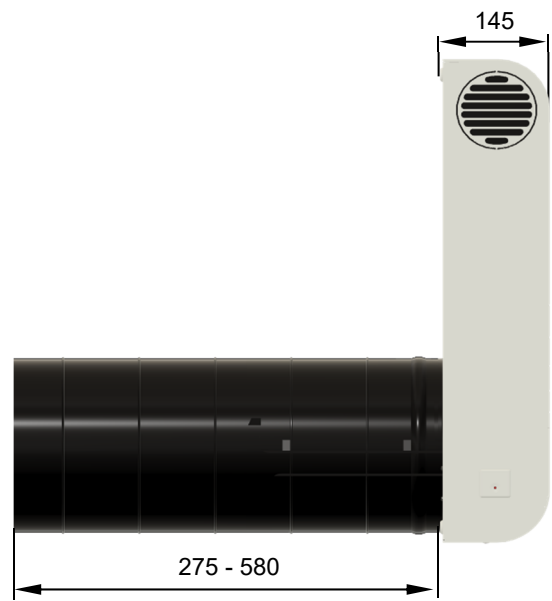

4.9.3 Terminal scheme

Version / version: Premium1	
Außenluft / intake air	T1 / isolating flap 1 / fan 1
Zuluft / supply air	
Fortluft / exhaust air	fan 2 / isolating flap 2
Abluft / extract air	sensor PHI / VOC PHI / CO2

DIP-switch SW1		
switch No.	function	factory setting
1	VOC / CO2 sensor active	ON
2	humidity sensor active	ON
3	boost ventilation function	OFF
4	bathroom function	OFF

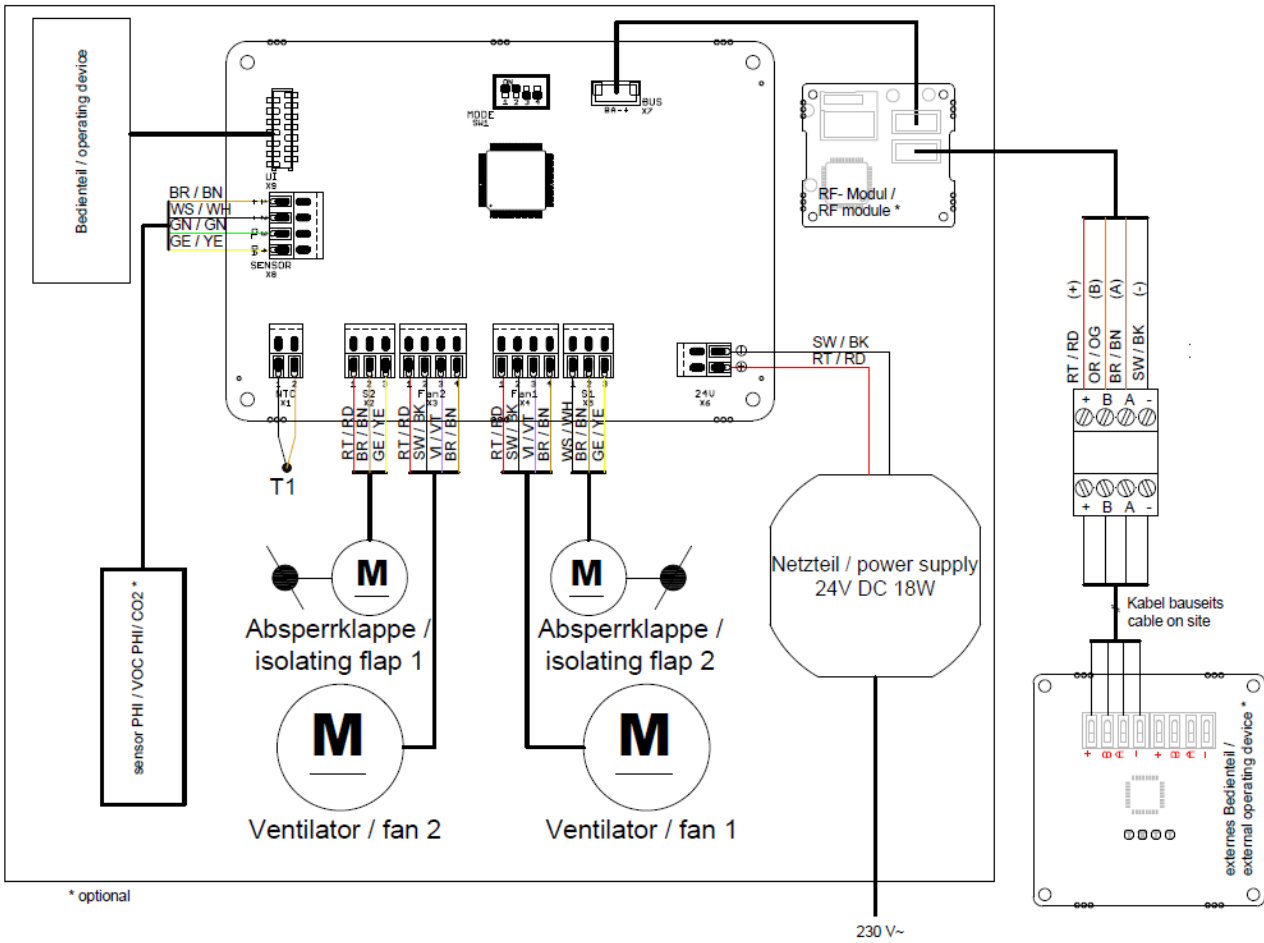

Sales International

Zehnder Group Deutschland GmbH
Almweg 34
77933 Lahr
Germany

T +49 7821 586 392

sales.international@zehndergroup.com
www.international.zehnder-systems.com

zehnder